

Pro-C

Residential and Light Commercial Irrigation Controllers

Indoor or Outdoor Versions

Owner's Manual and
Installation Instructions

Please leave with property owner

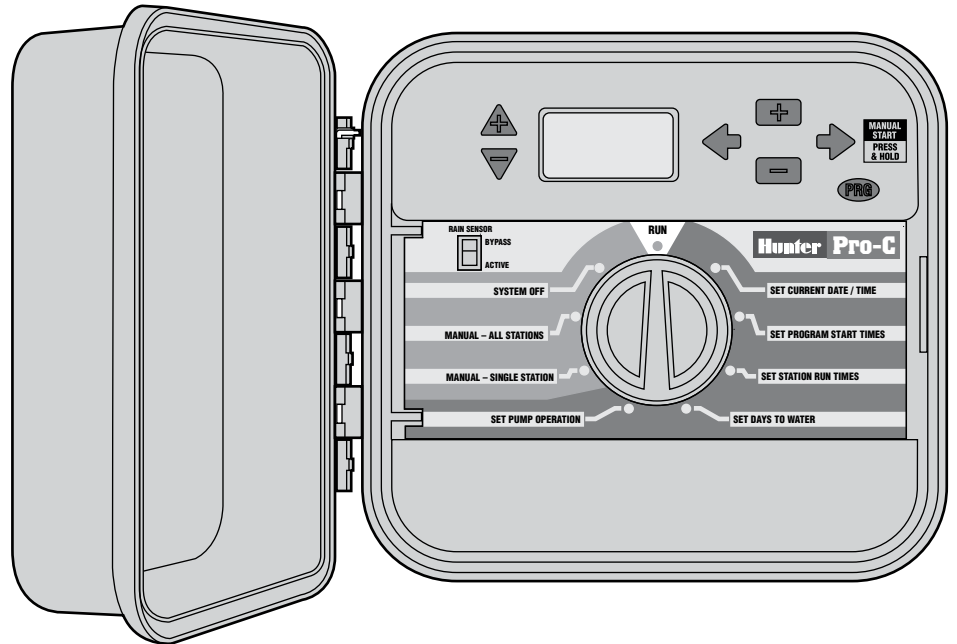

Hunter®

TABLE OF CONTENTS

INTRODUCTION AND INSTALLATION

Introduction	1
Pro-C Components	2
Pro-C Components – Wiring Cabinet	4
Mounting the Indoor Controller to Wall.....	6
Mounting the Outdoor Controller to Wall	7
Connecting Valves and AC Power	8
Installing Station Modules	10
Connecting the Battery.....	11
Connecting a Master Valve	11
Connecting a Pump Start Relay	12
Connecting a Weather Sensor.....	13
Rain Sensor Bypass	13
Connecting an SRR or ICR Remote Control.....	14
Connecting to the Hunter ET System	15
Connecting to the Hunter Irrigation Management and Monitoring System™.....	16
Power Failures.....	16

CONTROLLER PROGRAMMING AND OPERATION

Sprinkler System Fundamentals	17
Creating a Watering Schedule.....	18
How to Fill Out the Watering Schedule	18
Watering Schedule Form Example.....	19
Watering Schedule Form	20
Programming Fundamentals.....	21
Programming Fundamentals Example	22

TABLE OF CONTENTS (continued).....

Programming the Controller.....	23
Setting the Current Date and Time.....	24
Setting Program Start Times.....	24
Eliminating a Program Start Time.....	25
Setting Station Run Times (Length of Watering for Each Area).....	25
Setting Days to Water.....	26
Selecting Specific Days of the Week to Water.....	26
Selecting Interval Watering.....	26
Selecting Odd or Even Days to Water.....	27
Run.....	27
System Off.....	27
Manually Run a Single Station.....	27
Manually Run All Stations.....	28
One Touch Manual Start and Advance.....	28
Seasonal Adjustment.....	28
Advanced Features.....	29
Hidden Features.....	30

TROUBLESHOOTING AND SPECIFICATIONS

Troubleshooting Guide.....	32
Frequently Asked Questions.....	34
Specifications.....	34
FCC Notice.....	Back Cover

INTRODUCTION

Finally, there's an affordable, full-featured indoor/outdoor controller for both commercial and residential applications.

Hunter Industries is pleased to introduce the Pro-C Professional Controller for commercial and residential use. Designed with the needs of the customer in mind, the Pro-C offers simplified dial programming and an impressive range of features.

The Pro-C is a professional grade product. The controller's cabinet provides ample room for wiring. And the Pro-C is filled with essential features that landscapes demand like a rain sensor bypass circuit, primary and secondary power surge protection, seasonal adjustment/water budgeting, programmable pump/master valve circuit, programmable rain delay, three independent programs with four different day scheduling choices and four start times each, plus much more.

The Pro-C is so easy to use that you'll need this user guide very little after installation. If you do have a question about the controller, refer to this booklet or to the abbreviated instructions inside the door.

You can be sure that you've chosen with confidence. The Pro-C is a controller that does the job efficiently and economically.

PRO-C COMPONENTS

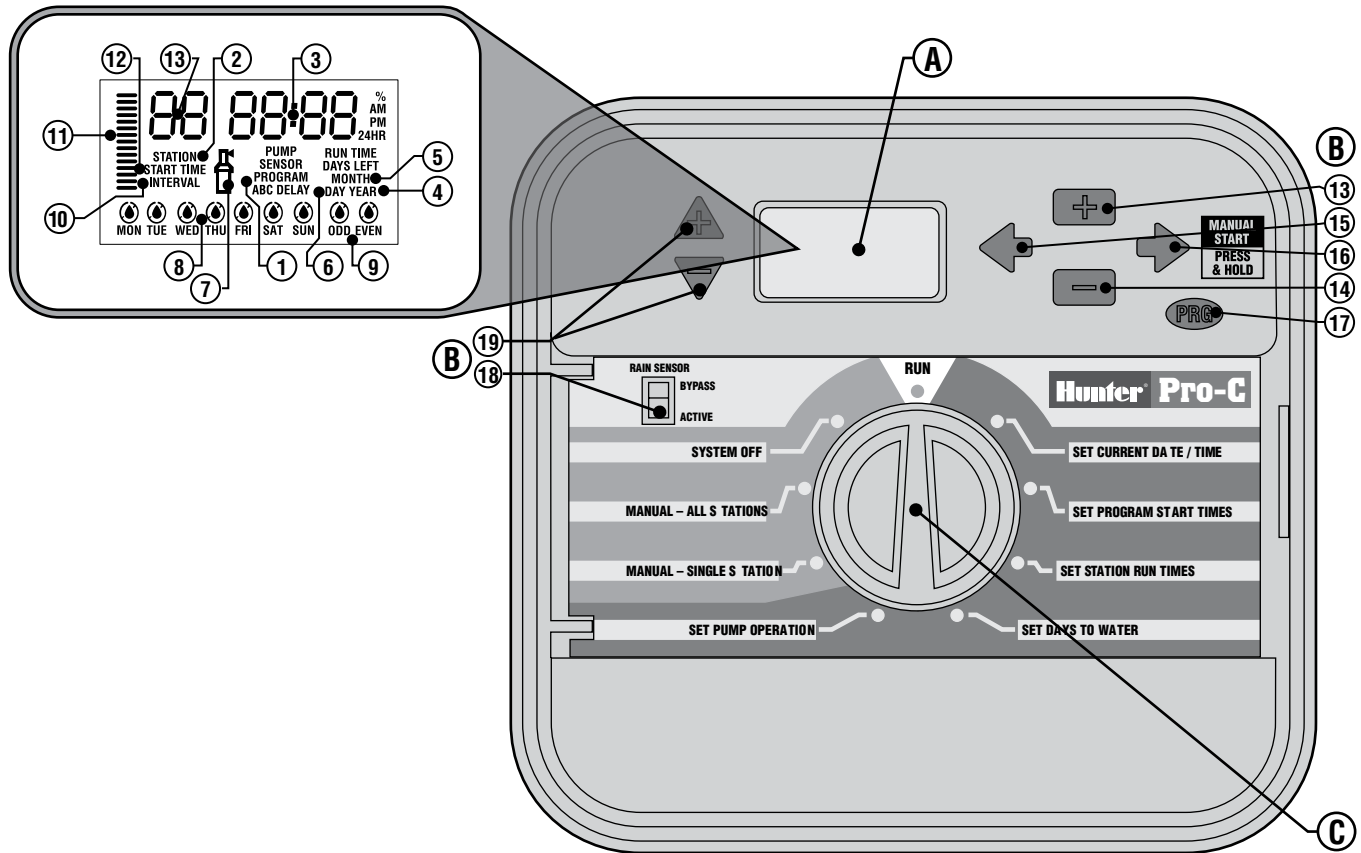

This section will give you a brief overview of some of the components on the Pro-C. Each item will be discussed in further detail later, however this section can be helpful in getting acquainted with the controller.

A. – LCD Display

1. **Program Selector** – Identifies the program in use A, B, or C.
2. **Station Number** – Identifies currently selected station number.
3. **Main Display** – Indicates various times, values, and programmed information.
4. **Year** – Identifies current calendar year.
5. **Month** – Identifies current calendar month.
6. **Day** – Identifies current calendar day.
7. **Running** – Sprinkler icon indicates when watering is occurring.
8. **Days of the week** – Identifies days of the week to water or not water. You can also select odd or even and an interval watering schedule.
9. **Odd/Even Watering** – Identifies if odd or even watering is selected.
10. **Interval** – Identifies if interval watering has been selected.
11. **Seasonal Adjust** – Displays in increments of 10%, the percentage of seasonal adjust that has been selected.
12. **Start Time** – Identifies selected start time. (Only appears on LCD main display when “Set Program Start Times” is selected.)

B. – Control Buttons and Switches

13. **+** **Button** – Increases the selected flashing display.
14. **-** **Button** – Decreases the selected flashing display.
15. **←** **Button** – Returns selected flashing display to the previous item.
16. **→** **Button** – Advances the selected flashing display to the next item. Also to start a manual cycle.
17. **PRO** **Button** – Selects programs A, B, and C. Also to start a test program.
18. **Rain Sensor Switch** – Allows user to bypass weather sensor, if one is installed.

19. **▲ and ▼ Buttons** – Used to increase or decrease the seasonal adjust option.

A key feature of the Pro-C is its clear, easy-to-use dial design that makes programming a snap. All essential keypad functions are clearly marked to eliminate the confusion that’s a characteristic of so many other controllers.

C. – Control Dial

- Run** – Normal dial position for automatic and manual operation.
- Set Current Date/Time** – Allows current date and clock time to be set.
- Set Program Start Times** – Allows 1 to 4 start times to be enabled in each program.
- Set Station Run Times** – Allows user to set each station run time.
- Set Days to Water** – Allows user to select individual days to water or to select an odd, even, or interval watering schedule.
- Set Pump Operation** – Allows user to turn off pump or master valve for specific stations.
- Manual – Single Station** – Allows user to activate a one time watering of a single station.
- Manual – All Stations** – Allows user to activate a one time watering of all stations or a few selected stations in a selected program.
- System Off** – Allows user to discontinue all programs and stop all watering until the dial is returned to the **RUN** position, or to set the programmable rain off feature.

PRO-C COMPONENTS – WIRING CABINET.....

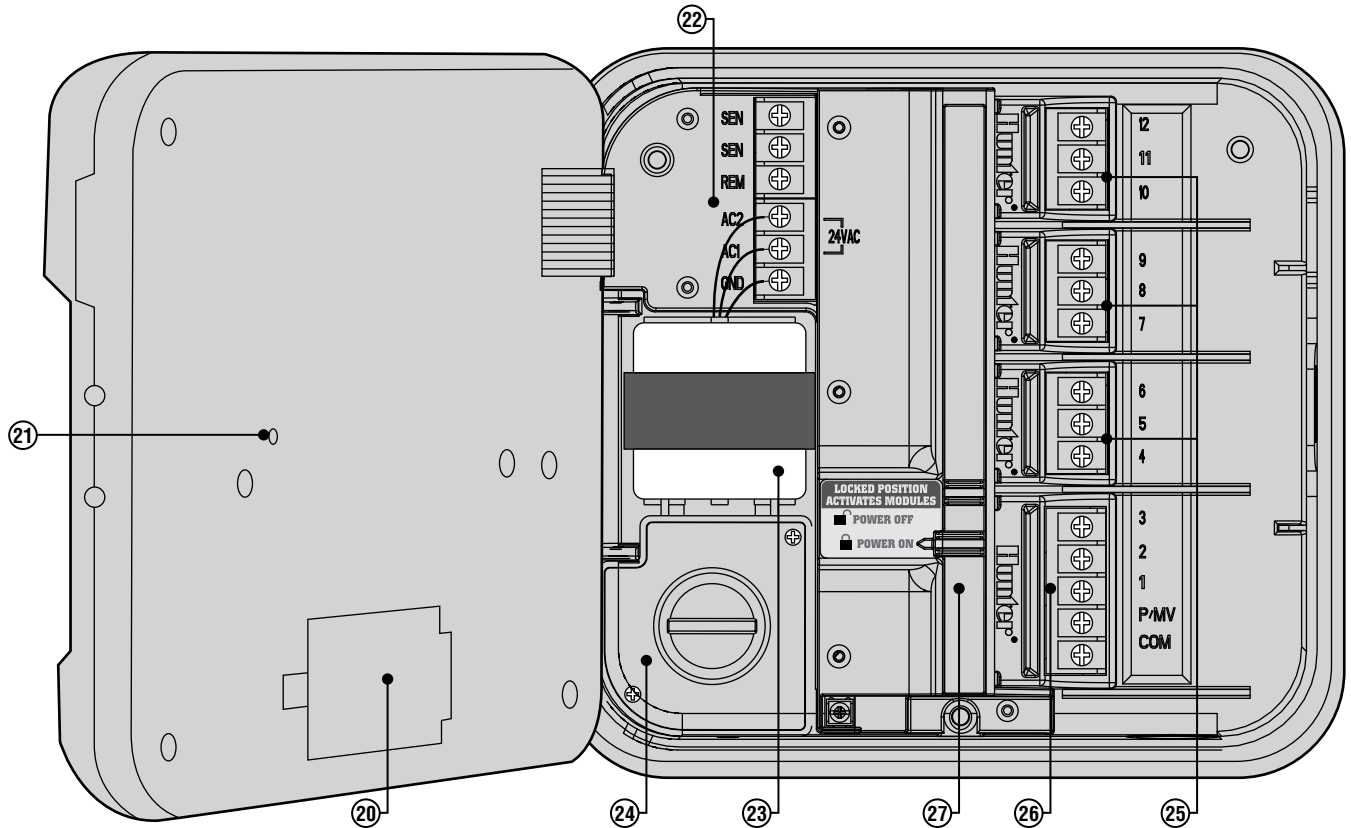

D. – Wiring Compartment

- 20. **9-Volt Battery** – An alkaline battery (not included) allows you to program the controller without AC power.
- 21. **Reset Button** – This button will reset the controller. All programmed data will remain intact.
- 22. **Power Area** – Used to attach transformer, sensor wires, and other systems from their source to the controller.
- 23. **Transformer** – A transformer is installed in the controller to route AC power from the power cable to the terminal strip area. (Outdoor models only, indoor models are supplied with a plug-in transformer.)
- 24. **Junction Box** – This box provides an area for connecting primary power. (Outdoor models only.)
- 25. **Station Modules** – There are 3 open module positions inside the controller. With the addition of up to 3 PCM-300 modules, you can run 3 to 12 stations. The addition of 1 PCM-300 and 1 PCM-900 (9-station module) will increase station capacity to 15 stations.
Note: The use of a PCM-900 to expand your controller to 15 stations requires that one PCM-300 be installed in the first slot (**stations 4-6**) and the PCM-900 in the upper two slots.
- 26. **Base Module** – Includes terminals for stations 1 through 3, the master valve (pump connection), and the common wire.
- 27. **Power-Lock Slide** – The Power-Lock feature will turn off power and unlock modules for removal. Once all modules have been installed, sliding the Power-Lock to the “ON” position activates power and locks modules in their expansion slots.

MOUNTING THE INDOOR CONTROLLER TO A WALL.....

All necessary hardware is included for most installations.



NOTE: The indoor Pro-C is not weather or water resistant, and must be installed indoors or in a protected area. This device is not intended for use by young children. Never let children play with this device.

1. Select a location as close as possible to a standard electrical outlet that is not controlled by a light switch. The location should be protected from moisture and direct sunlight. A 15 foot distance is recommended between the controller and any other electrical device to prevent the possibility of electrical interference.
2. Remove the front panel from the Pro-C by first removing the ribbon connector and then pulling down the hinge release and removing the ribbon connector. Removing the front panel will ease installation of the controller cabinet.
3. Place the controller at eye level. Use the hole at the top of the controller as a reference and secure one 25mm screw (A) into the wall. **Note: Install screw anchors if attaching to drywall or masonry wall.**
4. Align controller with the screw and slide the keyhole (B) on top of the controller over the screw.
5. Secure controller in place by installing screws in the holes (C).



NOTE: Do not plug transformer into power source until the controller is mounted and all valves have been connected.

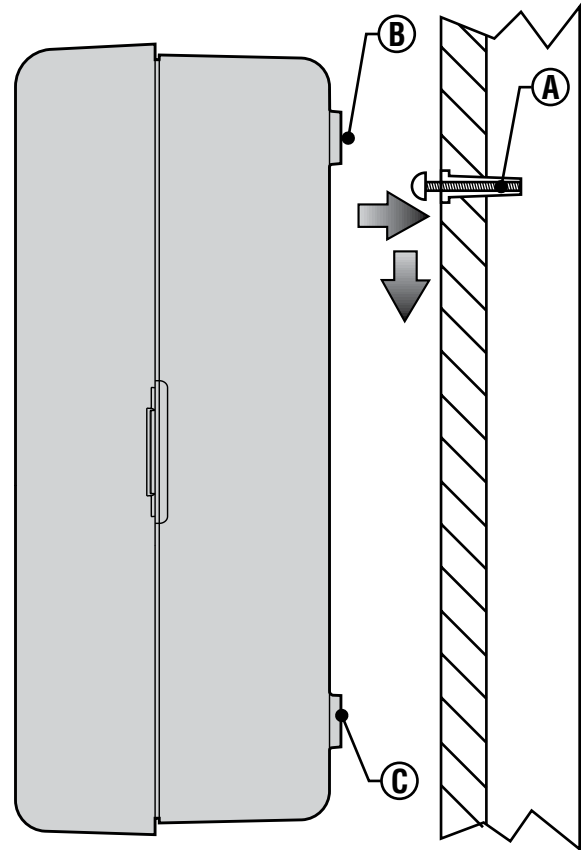

MOUNTING THE OUTDOOR CONTROLLER TO A WALL



NOTE: Outdoor model is water and weather resistant. Connecting the outdoor Pro-C to the primary power should be done by a licensed electrician following all local codes. Improper installation could result in shock or fire hazard. This device is not intended for use by young children. Never let children play with this device.

1. Select a location that is conveniently close to a power supply. A 15 foot distance is recommended between the controller and any other electrical device to prevent the possibility of electrical interference.
2. Make sure to abide by all electrical and installation codes when attaching to an external wall.
3. Remove the front panel from the Pro-C by first removing the ribbon connector and then pulling down the hinge release and removing the front panel. Removing the front panel will ease installation of the controller cabinet.
4. Place the controller at eye level and align keyhole **(A)** on top of the controller and mark the spot as well as the three holes **(B)** on the bottom of the unit.
5. Drill a 6 mm hole at each mark.
6. Install screw anchors **(C)** into holes if attaching controller to drywall, masonry, or plaster walls.
7. Holding the controller cabinet, line up the holes in the cabinet with the wall anchors or pilot holes.
8. Drive a screw through each hole and secure but do not over tighten.

For PC-301-A:

If the supply cord is damaged, it must be replaced by the manufacturer or service agent or a similarly qualified person in order to avoid hazard.

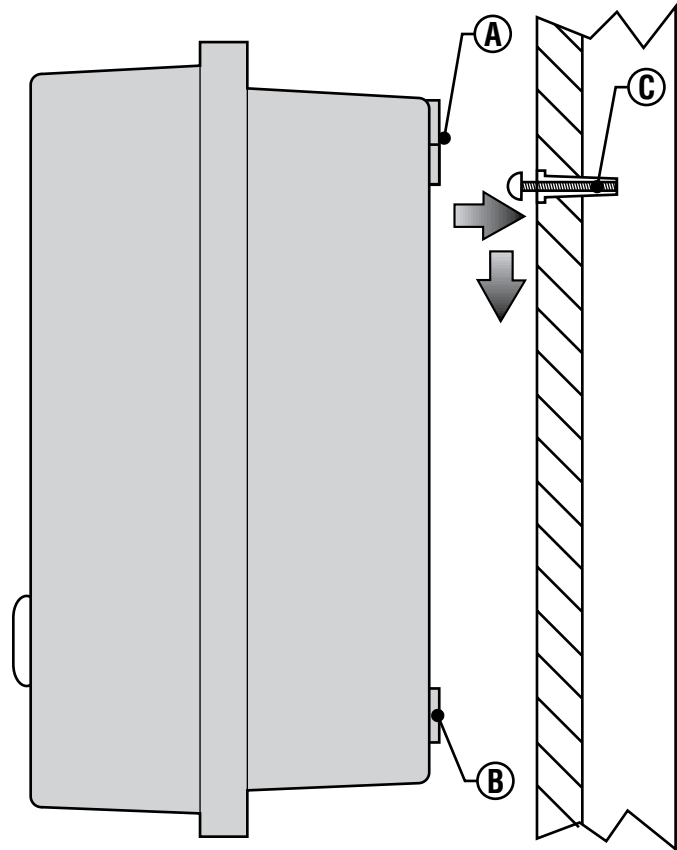

CONNECTING VALVES AND AC POWER.....

1. Route valve wires between control valve location and controller.
2. At valves, attach a common wire to either solenoid wire of all valves. This is most commonly a white colored wire. Attach a separate control wire to the remaining wire of each valve. All wire splice connections should be done using waterproof connectors.
3. Open hinged faceplate on the controller to access the terminal strip area.
4. Route valve wires through the conduit and attach conduit to the controller at the large conduit opening on the right side of the bottom of the cabinet. Refer to the conduit sizing chart on page 34 in the Frequently Asked Questions section if you are not sure what size conduit will work for your installation.
5. Strip ½" (13 mm) of insulation from ends of all wires. Secure valve common wire to "COM" (Common) terminal on the first module. Then attach all individual valve control wires to appropriate station terminals.

Indoor Cabinet

Route transformer cable through the hole on the bottom left side of the controller and connect the Yellow Wires to the screws marked **AC** and the Green Wire to **GND**. Before closing the compartment door make sure wires hang in the slotted areas so that the door can snap shut without damaging wires.

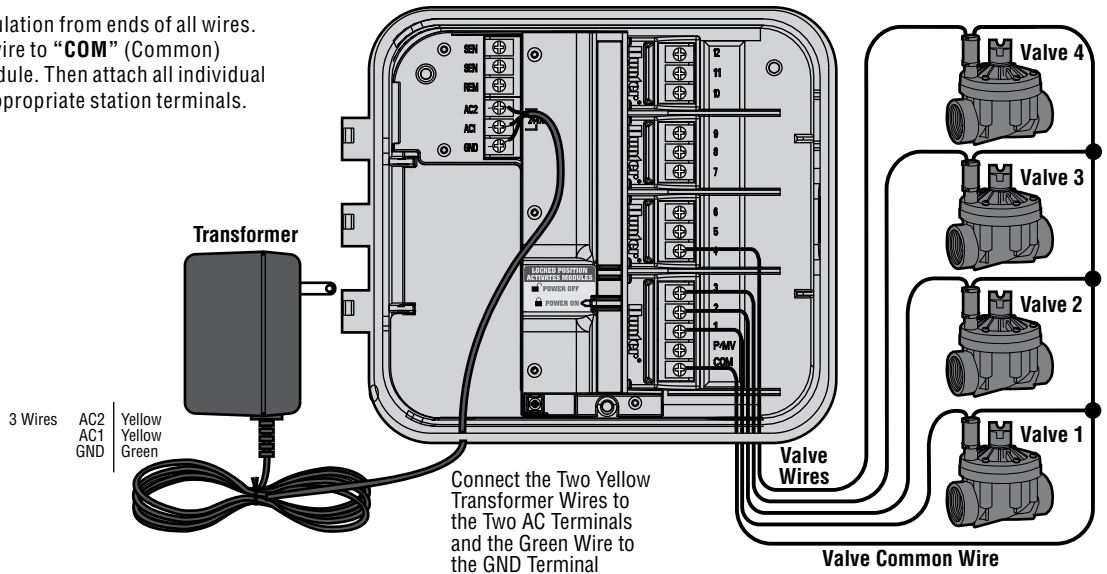



NOTE: It is recommended that a licensed electrician perform the following power installation.

Outdoor Cabinet

Route **AC** power cable and conduit through the $\frac{1}{2}$ " (13 mm) conduit opening on the left side of the bottom of the cabinet. Connect the wires to the transformer wires located inside the junction box. International units are supplied with a built in terminal strip. Always use a UL listed conduit $\frac{1}{2}$ " (13 mm) male adapter when installing the **AC** wiring. Insert the adapter (male threads first) into the $\frac{1}{2}$ " hole at the bottom of the controller until it enters the wiring enclosure. Attach the nut to the adapter inside the enclosure.



NOTE: Illustration shows international terminal strip. Domestic units are supplied with wires that must be connected with wire nuts or other locally approved connectors.

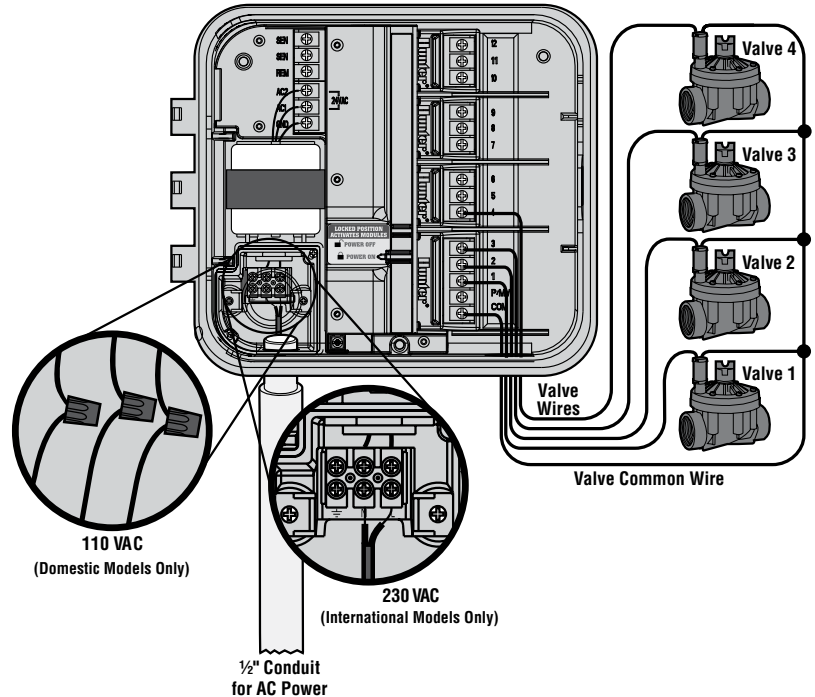

INSTALLING STATION MODULES

The Pro-C controller is supplied with a factory-installed base module for up to 3 stations. Additional modules may be added in increments of 3 stations (PCM-300) or a single 9-station (PCM-900) to expand the controller's station capability to 15 stations. Additional modules are sold separately.

Note: The use of a PCM-900 to expand your controller to 15 stations requires that one PCM-300 be installed in the first expansion slot (**stations 4-6**) and the PCM-900 in the upper two expansion slots.

The Pro-C utilizes automatic module recognition firmware to identify when PCM modules are installed or removed from the controller. This feature will recognize the correct number of stations without having to reset or cycle power to the controller.

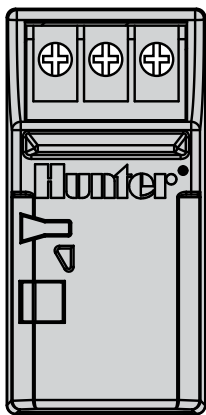

PCM-300

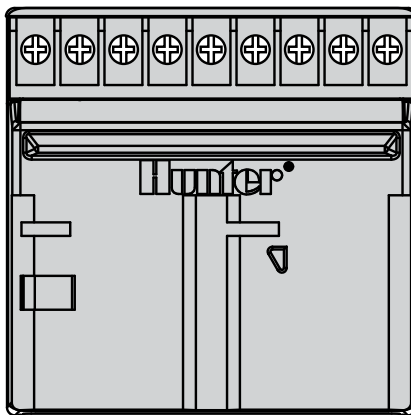

PCM-900 (Must be installed in the 9-12 station module slots and used along with one PCM-300 Module)

Installing PCM Modules

The Pro-C controller is designed with a simple to use Power Lock feature that assures that the modules are energized and firmly secured into the controller. The Power Lock can unlock or lock all modules at one time by simply pushing the Power Lock slide.

1. Slide the Power Lock into the Power Off (unlocked) position. Insert the PCM modules into the appropriate sequential position in the controller cabinet.

Note: Your Pro-C controller is designed to work only in conjunction with **BLACK PCM** expansion modules.

2. Once all of the modules are in place, slide the Power Lock into the Power On (locked) position to energize and secure the modules into the controller.

The Pro-C will automatically recognize the correct number of stations. It is not necessary to press the reset button or cycle power to the controller.

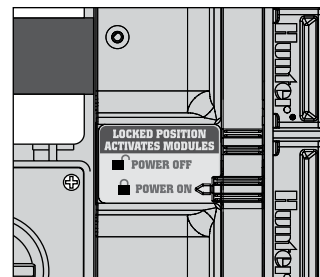

CONNECTING THE BATTERY FOR PROGRAMMING WITHOUT AC POWER (optional).....

Connect a 9-volt **alkaline** battery (not included) to the battery terminals and place in the battery compartment in the controller cabinet. The battery allows the user to program the controller without AC power. **Watering will not occur without AC power.** Since this controller has non-volatile memory, the program clock and calendar will be retained during a power outage even if no battery is installed.

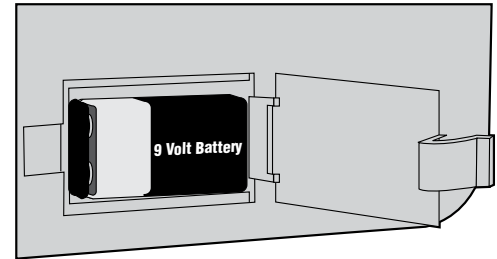

CONNECTING A MASTER VALVE.....



NOTE: Complete this section only if you have a master valve installed. A master valve is a normally closed valve installed at the supply point of the main line that opens only when the automatic system is activated.

1. At the Master Valve, attach the common wire to either solenoid wire of the valve. Attach a separate control wire to the remaining solenoid wire.
2. Route the wires into the controller via the field wire conduit.
3. Connect either wire from Master Valve to the **P/MV** terminal. Connect remaining wire to the "**COM**" (Common) terminal.

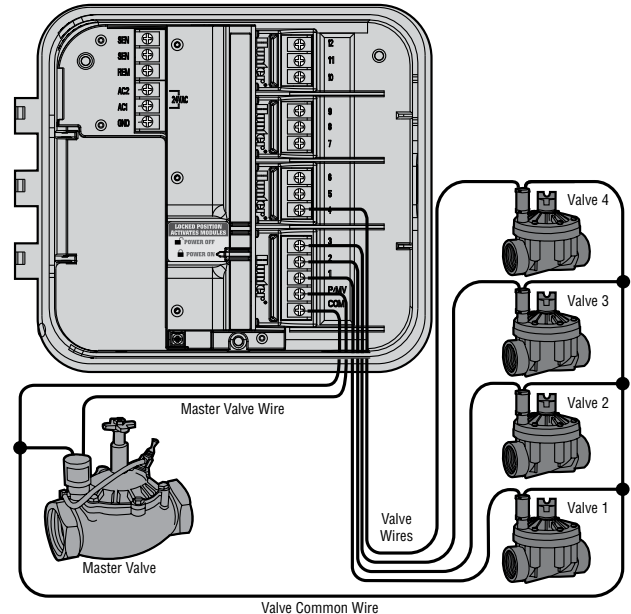

CONNECTING A PUMP START RELAY.....



NOTE: Complete this section only if you have a pump and pump start relay installed. A pump start relay is an electronic device that uses a signal current from the irrigation controller to activate a pump to provide water to your system.

The controller should be mounted at least 15 feet (4.5 m) away from both the pump start relay and the pump. When a pump is to be operated by the controller, a pump start relay must be used. Hunter offers a full range a pump start relays for most applications.

1. Route a wire pair from the pump relay into the controller housing.
2. Connect the pump common wire to the terminal slot “COM” (Common) and the remaining wire from the pump relay to the P/MV screw slot.

Relay holding current draw must not exceed .28 amps.
Do not connect the controller directly to the pump – damage to controller will result.

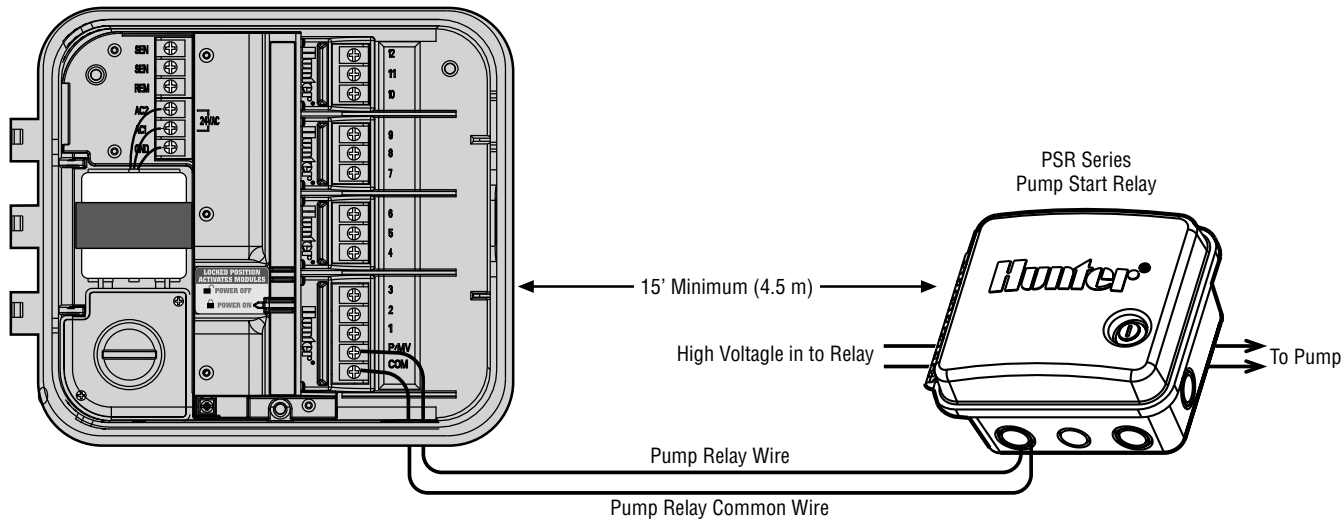

CONNECTING A WEATHER SENSOR (not included).....

A Hunter Mini-Clik® rain sensor or other type of micro-switch weather sensor may be connected to the Pro-C. The purpose of a rain sensor is to stop watering when precipitation is sufficient. The sensor connects directly to the controller and allows you to easily override the sensor by using the Rain Sensor bypass switch on the controller.

1. Route the wires from the rain sensor up through the same conduit used for valve wiring.
2. Remove the flat jumper from the two **SEN** terminals.
3. Connect one wire to the **SEN** terminal and one to the other **SEN** terminal.

NOTE: If the rain sensor switch is left in the **ACTIVE** position and no sensor is connected and the jumper has been removed, the display will read **SEN OFF** and no irrigation will occur. To eliminate this problem when no sensor is connected, leave the switch in the **BYPASS** position or install a short jumper wire between the sensor terminals.

Rain Sensor Bypass

With this built-in feature, there is no need for an additional manual bypass switch when using rain sensors (the Pro-C works with all Hunter sensors, plus other rain, wind, and freeze sensors on the market today). If the sensor is preventing system operation **SENSOR OFF** will be displayed. Simply move the switch to **BYPASS** and the weather sensor will be bypassed. This allows you to use the system.

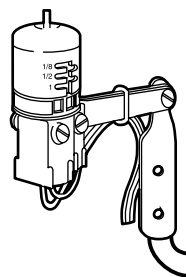
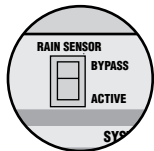

Mini-Clik®
Weather Sensor

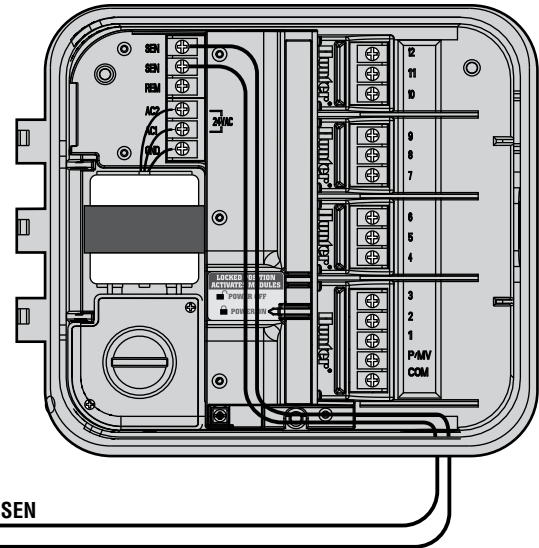

Sensor Wire to SEN

Sensor Wire to SEN

CONNECTING A WEATHER SENSOR (continued)

Testing a Weather Sensor

The Pro-C provides simplified testing of a rain sensor when the rain sensor is wired into the sensor circuit. It also provides the user the ability to override the rain sensor when necessary to perform system inspections and manual watering.

- **Testing the Rain Sensor**

The user can manually test the proper operation of the rain sensor by running a manual “all stations cycle” or by activating the system using the one touch manual method (see page 28). During the manual cycle, pressing the test button on the Mini-Click® will interrupt the watering indicating proper sensor operation.

- **Overriding the Rain Sensor**

Use of a Hunter remote control (single station operation only, not programs A, B, or C) and manual single station function on the Pro-C dial will override the rain sensor. This function provides the users the ability to operate the system even though the rain sensor has shut the system off.

CONNECTING AN SRR OR ICR REMOTE CONTROL (not included)

The Pro-C controller is shipped with a SmartPort® wiring harness, allowing for fast and easy use of the Hunter SRR, or Long Range ICR remote controls. The SRR and ICR make it possible for contractors and end users alike to operate a system without having to walk back and forth to the controller.

To utilize the SRR or ICR Remote Control System you must install the SmartPort connector (supplied with your Pro-C controller).

1. Install a ½" female threaded “Tee” in the field wiring conduit approximately 12" below the Pro-C.
2. Feed the red, white, and blue wires of the harness through the base of the “Tee” and into the wiring compartment as shown in Fig. 1.

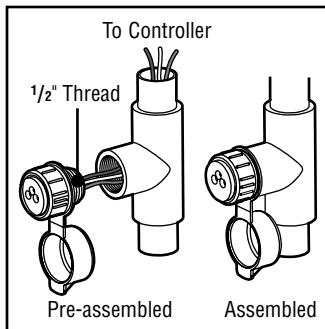

3. Screw the SmartPort harness housing into the “Tee” as shown in Fig. 1.
4. Access the terminal strip area and attach the red wire to the bottom most **AC** screw slot, attach the white wire to the upper **AC** screw slot and attach the blue wire to the screw slot marked **REM**.

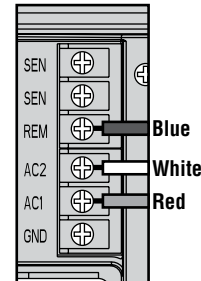

The SmartPort is now ready for remote control use. Please refer to either the SRR or ICR owner’s manual for further information or contact your local Hunter distributor for ordering information.



NOTE: Any extension of the wiring on the SmartPort® may result in an error message in the controller display and possible malfunction of the remote unit due to radio interference. In some situations, lengthening of the harness may work fine, in others it may not work at all (it is site specific). In either case, extending the wiring harness should be done using shielded cable to minimize the possible effects of electrical noise. For easiest installation, order a new Hunter SmartPort shielded cable wiring harness (part #SRR-SCWH) with a full 25 feet of shielded cable.

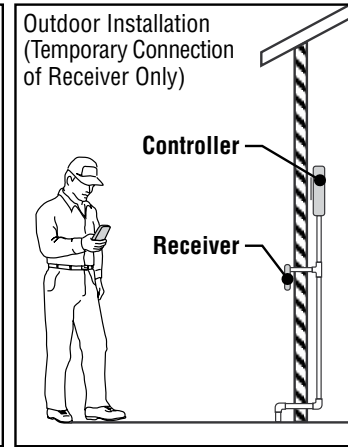
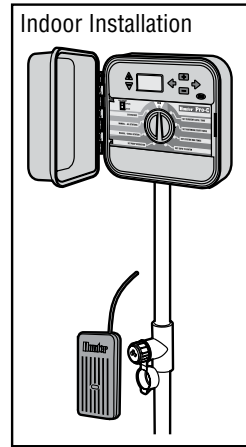

CONNECTING TO THE HUNTER ET SYSTEM

The Hunter ET System allows irrigation programs to be created automatically, based on local climate conditions. These programs are then loaded into the controller and run automatically. ET System uses sensor to determine the local “evapotranspiration” (ET) rate of turf and plants. The result is a new, water-efficient irrigation program every water day, based on local weather conditions. For more information on the ET System, contact your local Hunter dealer.

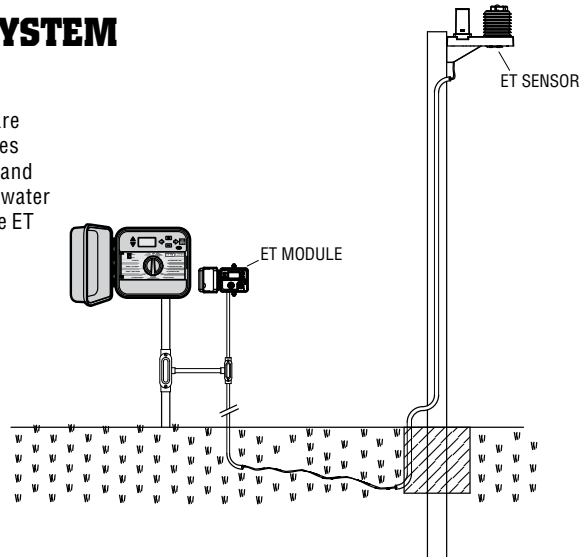

CONNECTING TO THE HUNTER IRRIGATION MANAGEMENT AND MONITORING SYSTEM™

With the Irrigation Management and Monitoring System™ (IMMS™), automatic irrigation systems at multiple sites or multiple controllers on a single site can be programmed for functions that would typically be handled directly at each site's controller. Scheduling of days to water, run times, start times, cycle and soak operations, and more can now be done from a single computer at a desk miles away from the actual installation.

In addition, scheduled operation of non-irrigation components also in use at these sites – e.g., lighting systems at athletic fields, fountains at shopping centers – as well as pumps and sensors can also be programmed and monitored from a single central location.

A key function of the IMMS is its ability to monitor changing conditions. With the aid of such options as flow sensors, rain sensors, and other weather-sensing devices, the IMMS can receive reports on the current condition at every site it is linked with and then respond with the necessary adjustments should any of those conditions go beyond the limits that have been defined.

No system available today is more cost-effective than the Hunter IMMS. It's inexpensively priced and contains the most essential features needed for water management. It's able to team with any or all of the standard automatic controllers in the Hunter line-up, from the SRC to the Pro-C to the ICC. Plus, it's a system that's easy and affordable to upgrade, making it possible to accommodate an expanding network of controllers.

For more information on the IMMS, contact your local Hunter dealer.

POWER FAILURES

Due to the possibility of power failures, the controller has non-volatile memory to preserve the program indefinitely. There is no default program.

The Pro-C is also capable of keeping the current time and date for an extended period of time during power outage conditions.

SPRINKLER SYSTEM FUNDAMENTALS.....

There are three main components that are involved with all automatic sprinkler systems that are made today. They are the **controller**, **valves**, and the **sprinklers**.

The **controller** is what makes the whole system operate efficiently. It is technically the brain of the entire system, instructing the valves when to supply water to the sprinklers and for how long to do so. The sprinklers, in turn, will direct the water towards the surrounding plants and lawn.

The **valve** controls a group of sprinklers called a watering **station**. These stations are laid out in a fashion according to the type of plant life that exists there, the locations of the plants, and the maximum amount

of water that can be pumped to the location. Each valve is connected via wire to the terminal strip area inside of the controller. Here the wire is connected to a number that corresponds to the valve's station number.

The controller will operate the valves in numerical sequence, only one at a time. When a valve has completed its watering; it will switch to the next station that has been programmed. This process is called the watering cycle. The information pertaining to the watering times of the individual stations and the duration of them is called a **program**.



- Valve 1** – Activates Station 1 – Rotors water front yard lawn
- Valve 2** – Activates Station 2 – Sprays water side lawn and bubblers water flowers
- Valve 3** – Activates Station 3 – Rotors water back yard lawn
- Valve 4** – Activates Station 4 – Bubblers water garden
- Valve 5** – Activates Station 5 – Sprays water side lawn and bubblers water flowers
- Valve 6** – Activates Station 6 – Sprays water front corner lawn

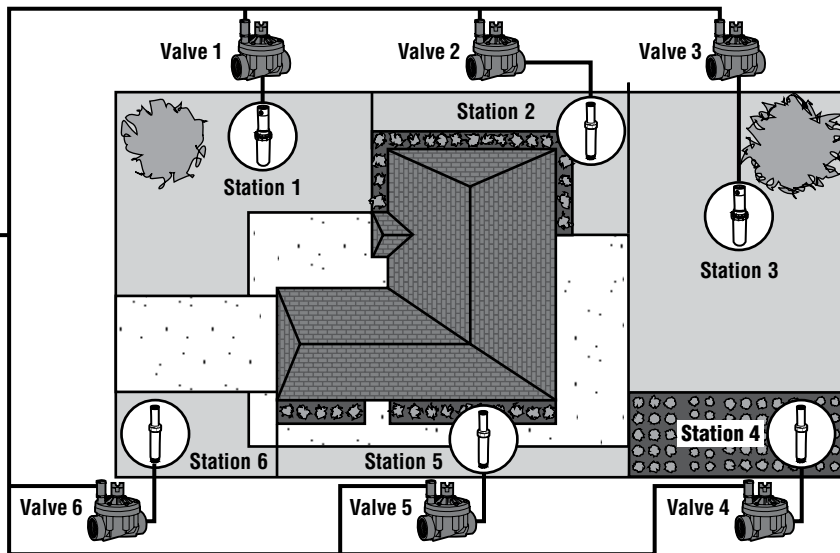

CREATING A WATERING SCHEDULE

For most consumers, it is much easier to plan your specific watering schedule onto paper before actually programming the information into the controller. It's also handy to have a written record of your programming information for easy reference.

There are some guidelines that should be followed when determining when and how long to water. These factors are the soil type, the part of the landscape being watered, weather conditions, and the types of sprinklers being used. Since there are so many different variables that can determine your individual watering schedule, it is impossible to give an exact schedule to follow. However, we have included some guidelines to help you get started.



NOTE: It is usually good to water one or two hours before sunrise. Water pressure will be at optimum levels during the early morning and the water can soak into the roots of the plants while evaporation is minimal. For most plants, watering during mid-day or in the evening may cause plant damage or possibly mildew.



NOTE: Keep an eye out for evidence of under- or over-watering. Over-watering is most commonly indicated by pools of water that take a long time to soak in or evaporate, while under-watered landscapes will show signs of discoloring and dryness. Make programming changes immediately when evidence is present.

HOW TO FILL OUT THE WATERING SCHEDULE

Be sure to use a pencil when filling out this form. By using the included example and the information below, you should have all the information you need to construct your personal water schedule.

Station Number and Location – Identify the station number, location and the type of plant that is being watered.

Watering Day – Identify whether you want to use a calendar day, interval, or an odd or even day schedule. For a calendar day schedule circle the day of the week in which watering is desired. For an interval schedule, indicate the desired interval number.

Program Start Times – Indicate the time of day that the program will begin. Each program can have 1-4 start times. However, one start time will run an entire program. Write “OFF” for any Pump Start Time not used.

Station Run Time – Indicate the run time (1 minute – 6 hours) for each station. Write “0:00” for any station that you do not want to operate in the program.

Keep this schedule in a safe place for quick reference later, rather than scrolling through program information on the controller.

WATERING SCHEDULE FORM EXAMPLE.....

HUNTER PRO-C		PROGRAM A						PROGRAM B						PROGRAM C								
DAY OF THE WEEK		M	T	W	T	F	S	S	M	T	W	T	F	S	S	M	T	W	T	F	S	S
ODD/ EVEN or INTERVAL		Every 1 day						Every 3 days						Every 20 days								
PROGRAM START TIMES	1	7:00 AM						9:00 AM						1:00 PM								
	2	OFF						OFF						OFF								
	3	OFF						OFF						OFF								
	4	OFF						OFF						OFF								
STATION	LOCATION	STATION RUN TIME						STATION RUN TIME						STATION RUN TIME								
1	Front Lawn	0:20						0:00						0:00								
2	Side Lawn	0:10						0:00						0:00								
3	Back Lawn	0:20						0:00						0:00								
4	Annuals	0:05						0:00						0:00								
5	Front Shrubs	0:00						0:15						0:00								
6	Back Shrubs	0:00						0:15						0:00								
7	Trees	0:00						0:00						3:00								
8																						
9																						
10																						
11																						
12																						
NOTES:																						

WATERING SCHEDULE FORM.....

HUNTER PRO-C		PROGRAM A							PROGRAM B							PROGRAM C							
DAY OF THE WEEK		1	2	3	4	5	6	7	1	2	3	4	5	6	7	1	2	3	4	5	6	7	
INTERVAL (Choose 1 to 31 days)																							
PROGRAM START TIMES		1																					
		2																					
		3																					
		4																					
STATION	LOCATION	STATION RUN TIME							STATION RUN TIME							STATION RUN TIME							
1																							
2																							
3																							
4																							
5																							
6																							
7																							
8																							
9																							
10																							
11																							
12																							
NOTES:																							

PROGRAMMING FUNDAMENTALS.....

A watering program can be created to operate valves in numerical sequence one at a time. All that is required to create a watering program is to:

1. Select a program (**A**, **B**, or **C**) by pressing the **PRG** button on the controller (it is recommended to start with **Program A**).
2. Set a program start time (only one program start time is required to activate a watering program).
3. Set the run time for each valve assigned to the program, and
4. Set the days that you would like the watering program to run.

We have included an example that will better illustrate the operation of a program:

Let's say you have a program start time set for 6:00 a.m. Stations 1 and 2 are going to have a run time of 15 minutes and station 3 is set for 20 minutes. Please note that stations 4, 5, etc. have not been included in this program, we will water them on separate programs.

Going back to our previous example, at 6:00 a.m. the controller will activate the watering cycle. The sprinklers on station 1 will run for 15 minutes and then shut off. The controller will automatically advance to station 2 sprinklers. These sprinklers will also run for 15 minutes and then shut off. Then, watering on station 3 will begin. The sprinklers will turn on for 20 minutes and shut off. Since no times were programmed for stations 4, 5, etc. the controller skips them. This will conclude the program and end the water cycle at 6:50 a.m.

As shown in the above example, only **one** program start time was required to run the three different stations. The controller automatically moves to the next station without the need for additional start times.

We realize that many consumers will have variations in their plant watering needs, so at Hunter we equipped the Pro-C with three different programs A, B, and C. These programs are independent of each other. However, no two programs can run at the same time. The Pro-C will automatically stack any programs that overlap. Programs scheduled to run at the same time will run in alphabetical order.

PROGRAMMING FUNDAMENTALS EXAMPLE

HUNTER PRO-C		PROGRAM A						
DAY OF THE WEEK		M	T	W	T	F	S	S
ODD/ EVEN or INTERVAL		Every 1 day						
PROGRAM START TIMES	1	7:00 AM						
	2	OFF						
	3	OFF						
	4	OFF						
STATION	LOCATION	STATION RUN TIME						
1	Front Lawn	15 minutes						
2	Shrub	15 minutes						
3	Side Yard	20 minutes						
4								
5								
6								
7								
8								
9								
10								
11								
12								
NOTES:								
Total Cycle of Program A = 50 minutes								

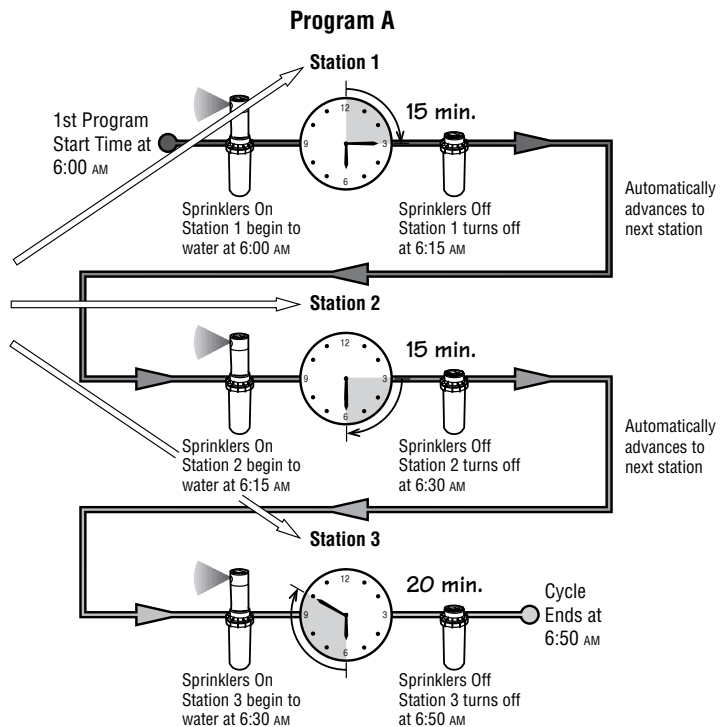

PROGRAMMING THE CONTROLLER

Two key features of the Pro-C that make programming a snap are its clear, easy-to-read LCD display and its easy-to-use dial design.

The Pro-C display shows time and day when the controller is idle. The display changes when the dial is rotated to indicate the specific programming information to enter. When programming, the flashing portion of the display can be changed by pressing the **+** or **-** buttons. To change something that is not flashing, press **←** or **→** until desired field is flashing.

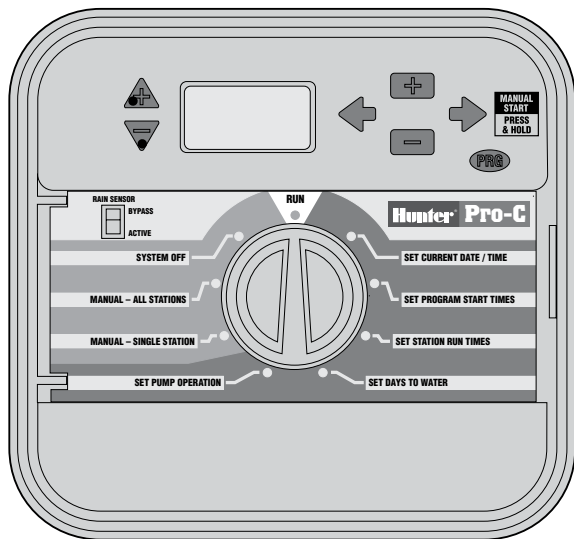

The Pro-C controller offers maximum scheduling flexibility including three programs, each with up to 4 daily start times, permitting plants with different watering requirements to be separated on different day schedules. Multiple start times permit morning, afternoon and evening

watering, perfect for the establishment of new lawns and thirsty annual flowers. A built in 365-day calendar clock accommodates odd/even watering restrictions without requiring monthly reprogramming. Or, just simply designate the days of the week you want to water or use the convenient day interval watering.



NOTE: A basic programming rule is that whatever symbol or character is flashing will be the item programmed. For instance, if the hour is flashing when setting the time, the hour can be changed or programmed. For illustration purposes, flashing characters are in GRAY type.

To activate a program in your controller, you must enter the following information:

1. Set current day and time – turn dial to **SET CURRENT DATE/TIME**.
2. Set what time of day you would like the program to start – turn dial to **SET PROGRAM START TIMES**.
3. Set how long each valve will water – turn dial to **SET STATION RUN TIMES**.
4. Set the day(s) you would like the program to water – turn dial to **SET DAYS TO WATER**.



NOTE: All stations operate in numerical order. Only one program start time is required to activate a watering program.

PROGRAMMING THE CONTROLLER (continued)

Setting the Current Date and Time

1. Turn the dial to the **SET CURRENT DATE/TIME** position.
2. The current year will be flashing in the display. Use the **+** and **-** buttons to change the year. After setting the correct year, push the **➔** button to proceed to setting the month.
3. The month and day will be in the display. The month will be flashing. Use the **+** and **-** buttons to change the month. Press the **➔** button to proceed to setting the day.
4. The day will be flashing: Use the **+** and **-** buttons to change the day of the month (The day of the week is automatically selected.) Press the **➔** button to proceed to setting the time.
5. The time will be displayed: Use the **+** and **-** buttons to select AM, PM, or 24 hr. Press the **➔** button to move to hours. Hours will be flashing. Use the **+** and **-** buttons to change the hour shown on the display. Press the **➔** button to move onto the minutes. Minutes will be flashing. Use the **+** and **-** buttons to change the minutes shown in the display. The date, day, and time have now been set.

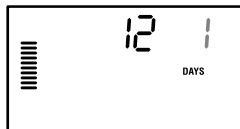
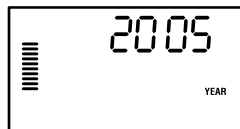
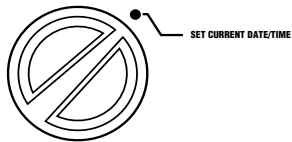

Setting Program Start Times

1. Turn the dial to the **SET PROGRAM START TIMES** position.
2. The factory preset is set on program **A**. If necessary you can select program **B** or **C** by pressing the **PRG** button.
3. Use the **+** and **-** buttons to change the start time. (Advances in 15-minute increments.) *One start time will activate all stations sequentially in that program.* This eliminates the need to enter a start time for each station. Multiple start times in a program can be used for separate morning, afternoon, or evening watering cycles.
4. Press the **➔** button to add an additional start time, or **PRG** button for the next program.

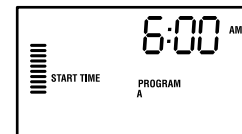
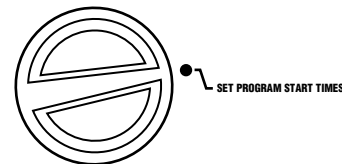

NOTE: Regardless of the order in which the start times are entered, the Pro-C will always arrange the start times in chronological order when the dial is moved off the **SET PROGRAM START TIMES** position.

Eliminating a Program Start Time

With the dial set to the **SET PROGRAM START TIMES** position, push the **+** and **-** buttons until you reach 12:00 AM (Midnight). From this position push the **OFF** button once to reach the **OFF** position.

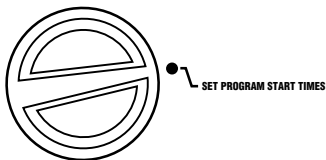

NOTE: If a program has all four start times turned off, then that program is off (all other program details are retained). Because there are no start times, there will be no watering with that program. This is a convenient way to stop watering on one program only without turning the dial to the off position.

Setting Station Run Times (Length of Watering for Each Area)

1. Turn the dial to the **SET STATION RUN TIMES** position.
2. The display will show the last program selected (**A, B, or C**) the station number selected, and the run time for that station will be flashing. You can switch to another program by pressing the **PRG** button.
3. Use the **+** and **-** buttons to change the station run time on the display.
4. Press the **➔** button to advance to the next station.
5. Repeat steps 4 and 5 for each station.
6. You may set station run times from 1 minute to 6 hours.
7. You can move between programs while staying on the same station. However, it is recommended that one program is completed before going on to the next program. Jumping between programs can be confusing and may result in program errors.

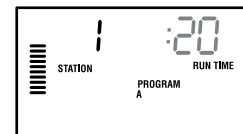

PROGRAMMING THE CONTROLLER (continued)

Setting Days to Water

1. Turn the dial to the **SET DAYS TO WATER** position.
2. The display will show the last program selected (**A**, **B**, or **C**). You can switch to another program by pressing the **PRG** button.
3. The controller displays currently programmed active day schedule information. This dial position provides four different water day options: you can choose to water on specific days of the week, or you can choose interval watering, or choose to water on odd days or even days. Each program can only operate using one type of water day option.

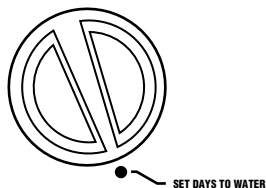

Selecting Specific Days of the Week to Water

1. Press the **+** button to activate a particular day of the week to water (the display always starts with Monday). Press the **-** button to cancel watering for that day. After pressing a button the display automatically advances to the next day. A indicates a water day. A indicates a no water day.

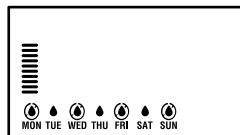

2. Repeat step 1 until desired days have been selected.

After programming, set dial to **RUN** to enable automatic execution of all selected programs and start times.

Selecting Interval Watering

This feature is convenient if you want to have a more consistent watering schedule without having to worry about the day of the week or the date. The interval you select is the amount of days between watering including the watering day. For example, an interval of 3 will water once every third day. The days remaining indicates how many days until the next watering.

For example if you select an interval of 3 with 1 day remaining, watering will begin tomorrow at the scheduled time.

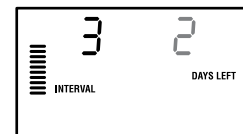
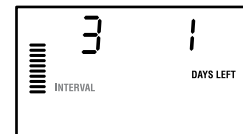
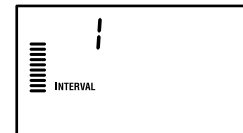

1. Turn the dial to **SET DAYS TO WATER**. The water drop above Monday should be flashing.
2. Press the **➡** button until the drop over Sunday is flashing, then press the **➡** button one more time. The display will change to the interval mode and the Interval Day number will be flashing.
3. Press the **+** or **-** button to select the Interval Day(s) you desire.
4. Push the **➡** button once to advance to the Days Left number.
5. Press the **+** or **-** button to select the Days Left you desire (0 Days left is the water day and will run the next available Start Time).
6. Turn the dial to **RUN**.



NOTE: If any days are selected as non-water days at the bottom of the display, the Interval Day watering will exclude those days. For example, if the Interval Days are set at 5 and Monday is a non-water day, the controller will water every 5th day, but never on a Monday. If the interval water day falls on a Monday and Monday is a non-water day. The program would not water for 5 more days resulting in no irrigation for 10 days total.

Selecting Odd or Even Days to Water

This feature uses a numbered day of the month for watering instead of specific days of the week (odd days 1st, 3rd, 5th, etc.; even days 2nd, 4th, 6th, etc.).

1. Using the instructions for **Interval Watering**, set the interval to one.
2. When in the interval mode the days along the bottom of the display indicate **No Water Days**. The  icon indicates no watering for that day. Press the  button until the cursor is on either **EVEN** or **ODD** in the display. Select whichever you choose as **No Water Days** by pressing the  button. If you select **ODD** as **No Water Days** then the controller will only water on even days of the month. Conversely, if you select **EVEN** as **No Water Days** then the controller will only water on odd days of the month.

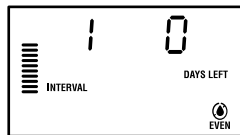

 = will water on **EVEN** Days /  = will water on **ODD** Days

You can also set particular days of the week as no water days using this feature (see Advanced Features on page 30).

3. Turn the dial to the **RUN** position to enable automatic watering.



NOTE: The 31st of any month and February 29th are always "off" days if Odd watering is selected.



Run

After programming is complete, turn the dial to **RUN** to enable automatic execution of all selected programs and start times.

System Off

Valves currently watering will be shut off after the dial is turned to the **SYSTEM OFF** position for two seconds. All active programs are discontinued and watering is stopped. To return controller to normal automatic operation, simply return dial to **RUN** position.

Manually Run a Single Station

1. Turn the dial to the **MANUAL-SINGLE STATION** position.
2. Station run time will flash in the display. Use the  button to move to the desired station. You may then use the  and  buttons to select the amount of time for a station to water.
3. Turn the dial to the **RUN** position to run the station (only the designated station will water, then controller will return to automatic mode with no change in the previously set program).

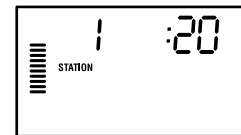
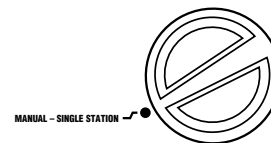
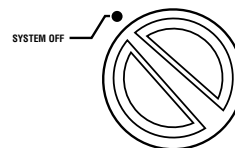
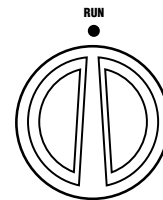

NOTE: This function will override the sensor.

PROGRAMMING THE CONTROLLER (continued)

Manually Run All Stations

1. Turn the dial to **MANUAL-ALL STATIONS**.
2. You can select program **A**, **B**, or **C** by pressing the **PRG** button.
3. Press the **➡** button until desired starting station is displayed.
4. Station run time will flash in the display. Use the **+** and **-** buttons to select the amount of run time for the station to water if different from the run time displayed.
5. Use the **➡** button to move to the next station.
6. Repeat steps 3 and 4 to customize each station if desired.
7. Press the **➡** button until desired starting station is displayed.
8. Return the dial to **RUN** (custom program will water the entire program beginning with the station number last left in the display, then controller will return to automatic mode with no change in the previously set program).

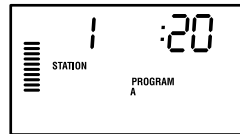
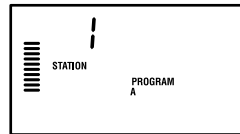
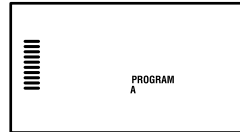
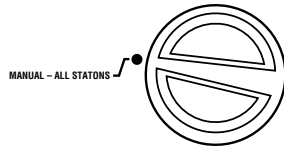

NOTE: The station that is on the display when you turn the dial to **RUN**, will be the first station to run. The controller will then proceed to water in sequential order only. It will not water previous stations.

One Touch Manual Start and Advance

You can also activate a program to water without using the dial.

1. Hold down the **➡** button for 2 seconds.
2. This feature automatically defaults to program **A**. You can select program **B**, or **C** by pressing the **PRG** program.
3. The station number will be flashing. Press the **⬅** or **➡** button to scroll through the stations and use the **+** and **-** buttons to adjust the station run times. (If no buttons are pressed during step 2 or 3, the controller will automatically begin program **A**.)
4. Press the **➡** button to scroll to the station you wish to begin with. After a 2 second pause, the program will begin.

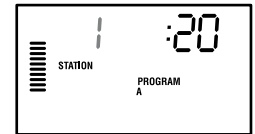
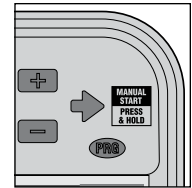

This feature is great for a quick cycle when extra watering is needed or if you would like to scroll through the stations to inspect your system.

Seasonal Adjustment

Seasonal Adjust is used to make global run time changes without re-programming the entire controller. This feature is perfect for making small changes that are necessary as the weather changes without reprogramming the entire controller. For instance, hotter times of the year may require a bit more water. Seasonal adjust can be increased so that the stations will run longer than the programmed time. Conversely, as Fall approaches, the seasonal adjust can be reduced to allow for short watering durations.

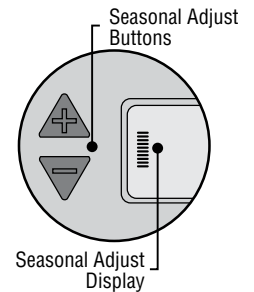

To use the seasonal adjust, simply press the up or down seasonal adjust buttons to set the percentage desired. Each bar on the graph can be adjusted from 10% to 150% of original program. The season adjust can be changed at any time regardless of the programming dial position. To view the new adjusted run time, simply turn the rotary dial to the Set Run Times position, the displayed run time will be updated accordingly as the seasonal adjustment is made.

 **NOTE: The controller should always be initially programmed in the 100% position.**

ADVANCED FEATURES

There are three advanced features available to customize the Pro-C to more complex watering requirements. One of these features is “hidden” to make accidentally programming them nearly impossible.

1) Set Pump/Master Valve Operation

The default is for all stations to have the master valve/pump start circuit **ON**. The master valve/pump start can be set **ON** or **OFF** by station, regardless of which program the station is assigned. This feature may be utilized on systems where it is desirable for a booster pump not to operate with certain zones.

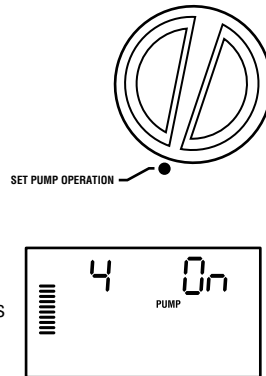

To program pump operation:

1. Turn the dial to **SET PUMP OPERATION** position.
2. Press the **+** or **-** buttons to toggle the master valve/pump start **ON** or **OFF** for the specific station.
3. Press the **➡** button to advance to the next station.
4. Repeat steps 2 and 3 for all necessary stations.

2) Programmable Rain Off

This feature permits the user to stop all programmed waterings for a designated period from 1 to 7 days. At the end of the programmable rain off period, the controller will resume normal automatic operation.

1. Turn the dial to the **SYSTEM OFF** position.
2. Press the **+** button and a 1 will be displayed and the **DAYS LEFT** icon will illuminate. The 1 will be blinking at this point.
3. Press **+** as many times as needed to set the number of days off desired (up to 7).
4. To validate this setting (and to make sure the controller comes back on after the period is over), turn the dial back to the **RUN** position at which time, **OFF**, a **number** and the **DAYS** icon all remain on.
5. Leave the dial in the **RUN** position.

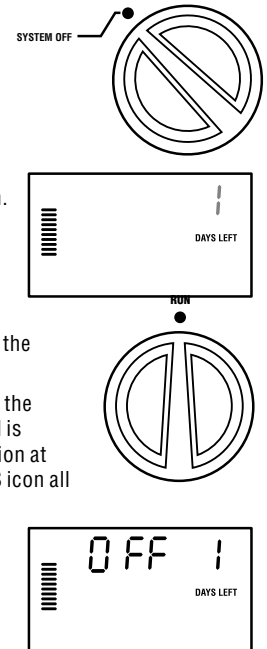

The days off remaining will decrease at midnight of each day. When it goes to zero, the display will show the normal time of day and normal irrigation will resume at the next scheduled start time.

ADVANCED FEATURES (continued)

3) Setting Specific Day(s) Off

Programming in a No Water Day(s) is useful to inhibit watering on mowing days, etc. For instance, if you always mow the lawn on Saturdays you would designate Saturday as a **No Water Day** so you are not mowing wet grass.

1. Turn the dial to the **DAYS TO WATER** position.
2. Enter an interval watering schedule as described on page 26.
3. With the days left flashing, press **➔** button to display the days of the week. **MON** will be flashing.

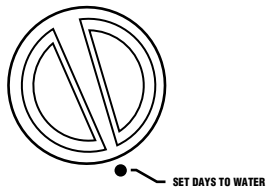

4. Use the **➔** button until the cursor is at the day of the week you wish to set as a **No Water Day**.
5. Press the **■** button to set this day as a no water day. The **●** will illuminate over this day.
6. Repeat steps 4 and 5 until all desired event day(s) are off.

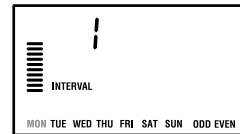

HIDDEN FEATURES

1) Programmable Delay Between Stations

This feature allows the user to insert a delay between when one station turns off and the next station turns on. This is very helpful on systems with slow closing valves or on pump systems that are operating near maximum flow or have slow well recovery.

1. Start with the dial in the **RUN** position.
2. Press and hold the **■** button down while turning the dial to the **SET STATION RUN TIMES** position.

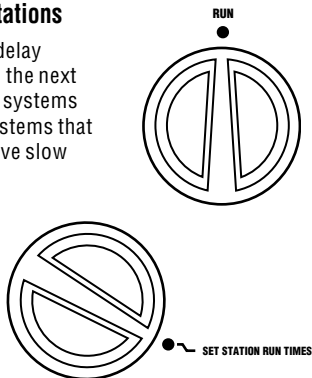

3. Release the **■** button. At this point the display will show a delay time for all stations in seconds, which will be blinking. The **DELAY** icon shall also be lit at this time.
4. Press the **+** and **-** buttons to increase or decrease the delay time between 0 and 59 seconds in 1 second increments and then in one minute increments up to four hours. **Hr** will be displayed when the delay changes from seconds to minutes and hours.
5. Return the dial to the **RUN** position.

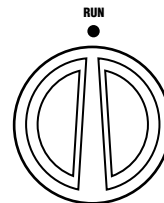
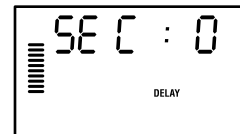



NOTE: The Master Valve/Pump Start circuit will operate during the first 15 seconds of any programmed delay to aid in the closing of the valve and to avoid unnecessary cycling of the pump. It is recommended that a pressure relief valve be installed on the system should this one minute be too long for a particular system. Consult your pump contractor or supplier for details.

2) Test Program

The Pro-C allows the user a simplified method for running a test program. This feature operates each station in numerical sequence, from the lowest to the highest. You can start with any station. This is a great feature to check the operation of your irrigation system.

To initiate the test program:

1. Press and hold the **PRG** button. The station number will be flashing.
2. Press the **←** or **→** button to scroll to the station you would like the test program to start with. Use the **+** and **-** button to set a run time of up to 15 minutes. The run time needs to be entered only once.
3. After a 2 second pause, the test program will begin.

3) Hunter Quick Check™

Irrigation professionals are continuously looking for ways to more efficiently and effectively diagnose programs in the field. Instead of having to physically check each field wiring circuit for potential problems, the user can run the Hunter Quick Check™ circuit test procedure. This circuit diagnostic procedure is very beneficial because of its ability to aid in quickly identifying “shorts” commonly caused by faulty solenoids or when a bare common wire touches a bare station control wire.

To initiate the Hunter Quick Check test procedure; Press the **+**, **-**, **←** and **→** buttons simultaneously. In the standby mode, the LCD will display all segments (helpful when troubleshooting display

problems). Press the **+** button to begin the Quick Check test procedure. Within seconds, the system searches all stations in an effort to detect a high current path through the station terminals. When a field wiring short is detected, an ERR symbol preceded by the station number will momentarily flash on the controller LCD display. After the Hunter Quick Check completes running this circuit diagnostic procedure, the controller returns to the automatic watering mode.

4) Clearing Controller's Memory/Resetting Controller

If you feel that you have misprogrammed the controller, there is a process that will reset the memory to factory defaults and erase all programs and data that have been entered into the controller. Press the **→**, **-**, and the **PRG** buttons simultaneously and hold them down, while they are being held down, press and release the RESET button on the back of the front panel. Then release the **→**, **-**, and the **PRG** buttons. The display should now show 12:00 am. All the memory has been cleared and the controller may now be reprogrammed.

WINTERIZING YOUR SYSTEM

In regions within the country where the frost level falls below the depth of the installed piping, it is common for these systems to be “winterized”. Several methods can be used to drain the water from the system. If the blow out method is used it is recommended that a qualified licensed contract perform this type of winterization.

WARNING! WEAR ANSI APPROVED SAFETY EYE PROTECTION!

Extreme care must always be taken when blowing out the system with compressed air. Compressed air can cause serious injury, including serious eye injury from flying debris. Always wear ANSI approved safety eye protection and do not stand over any irrigation components (pipes, sprinklers, and valves) during blow out. **SERIOUS PERSONAL INJURY MAY RESULT IF YOU DO NOT PROCEED AS RECOMMENDED.**

TROUBLESHOOTING GUIDE

PROBLEM	CAUSES	SOLUTIONS
The controller repeats itself or continuously waters, even when it should not be on (cycling repeatedly).	Too many start times (user error).	Only one start time per active program is required. Refer to “Setting Program Start Times” on page 24.
There is no display.	Check AC power wiring.	Correct any errors.
The display reads “ERR”.	Electrical noise is entering the system.	Check the SmartPort® wiring harness. If the wires were extended then they will need to be replaced with shielded cable. Contact your local distributor for information on shielded cable
The display reads “P ERR”.	There is a fault in the wire to the pump start or master valve.	Check the master valve or pump start wire for continuity. Replace or repair the shorted wire. Check that all wire connections are good and water tight.
The display reads a station number and ERR, such as “2 ERR”.	There has been a fault with the wire leading to that station.	Check the station wire for continuity. Replace or repair shorted wire. Check that all wire connections are good and water tight.
The display reads “NO AC”.	There is no AC power present (the controller is not receiving power).	Check to see if the transformer is properly installed.

PROBLEM	CAUSES	SOLUTIONS
The display reads “SENSOR OFF”.	The rain sensor is interrupting irrigation or the sensor jumper is not installed.	Slide the Rain Sensor switch on front panel to the BYPASS position to bypass rain sensor circuit, or install the sensor jumper.
Rain sensor will not shut off system.	Incompatible rain sensor or the jumper was not removed when sensor was installed. (Man. 1 Station Override)	Make sure sensor is micro-switch type such as Mini-Clik® (Rain Bird® Rain Check is not this type and will not work). Check that the the jumper has been removed from the the SEN terminals. Confirm proper operation (see "Testing a Weather Sensor" on page 14).
The controller does not have a start time for each station.	Programming error, dial in incorrect position.	Be sure the dial is in correct position. Total number of stations can be easily checked by placing dial in SET STATION RUN TIMES position and pressing the back arrow.
Valve will not turn on	Short in wiring connections. Bad solenoid. Power-Lock Slide in “Power OFF” position.	Check field wiring. Replace solenoid. Slide Power-Lock to “Power ON” position (see page 10).

FREQUENTLY ASKED QUESTIONS

WHAT SIZE FIELD WIRING CONDUIT SHOULD I USE?

Locate the size conduit across the top and the wire size along the side. Where the two intersect on the table tells you approximately how many wires will fill the conduit.

CONDUIT SIZES		
Wire Size	¾" (19 mm)	1" (25 mm)
18 AWG	12	20
16 AWG	10	16
14 AWG	6	10
12 AWG	5	7

For **Frequently Asked Questions** visit our website at www.HunterIndustries.com

SPECIFICATIONS

Operating Specifications

- Station Run Time: 1 minute to 6 hours on programs A, B, and C.
- Start Times: 4 per day, per program, for up to 12 daily starts.
- Watering Schedule: 7-day calendar, interval watering up to a 31-day interval or true odd or even day programming, made possible by the 365-day clock/calendar.

Electrical Specifications

- Transformer Input: 120VAC, 60Hz (230VAC, 50/60 Hz International Use)
- Transformer Output: 25 VAC, 1.0 amp
- Station Output: 24VAC, .56 amps per station
- Maximum Output: 24VAC, .84 amps (includes Master Valve Circuit)
- Battery: 9-volt alkaline battery (not included) used only for non-AC programming, the non-volatile memory maintains program information

Dimensions

Indoor Cabinet

Height: 8.25"
Width: 9.5"
Depth: 3.75"

Outdoor Cabinet

Height: 9"
Width: 10"
Depth: 4.5"

Default Settings

All stations are set to zero run time. This controller has a non-volatile memory that retains all entered program data even during power outages, without need for a battery.

INFORMATION ABOUT YOUR SPRINKLER SYSTEM.....

Date of Installation: _____

Contractor Installing System: _____

Address: _____

Phone: _____

Location of Control Valves: _____

Location of Weather Sensor: _____

Location of Main Water Supply Shutoff: _____

FCC NOTICE.....

This controller generates radio frequency energy and may cause interference to radio and television reception. It has been type tested and found to comply with the limits for a Class B computing device in accordance with the specifications in Subpart J of Part 15 of FCC Rules, which are designed to provide reasonable protection against such interference in a residential installation. However, there is no guarantee that interference will not occur in a particular installation. If this equipment does cause interference to radio or television reception, which can be determined by turning the equipment off and on, the user is encouraged to try to correct the interference by one or more of the following measures:

- Reorient the receiving antenna
- Move the controller away from the receiver
- Plug the controller into a different outlet so that controller and receiver are on different branch circuits

If necessary, the user should consult the dealer or an experienced radio/television technician for additional suggestions. The user may find the following booklet prepared by the Federal Communications Commission helpful: "How to Identify and Resolve Radio-TV Interference Problems." This booklet is available from the U.S. Government Printing Office, Washington, D.C., Stock No. 004-000-00345-4 (price – \$2.00)